

# Technical Data Sheet



## Catalog No. P48GF21-1

Characteristics	
Phase	1
KVA	1
Primary	480V
Secondary	120/240v
Conductor	Copper
Temp. Rise	115° C
Frequency	60 HZ
Taps	-2@5%
ESS	No
Insulation	180° C
Weathershield	N/A
Wall Bracket	Built-In
Weight(lbs)	28
Sound(dB)	40

**Notes**

All units are UL listed and are designed in accordance with applicable NEMA, ANSI and IEEE standards.

Transformers are dry-type AA, non-ventilated NEMA 3R enclosure.

Transformers are wall mounted. Wall mounting bracket is built into the enclosure.

Paint color is ANSI 61.

**AMP Ratings**

<b>Line In (Primary) @ 480V</b>	2.1A
<b>Load (Secondary) @ 120V</b>	8.3A
<b>Load (Secondary) @ 240v</b>	4.2A

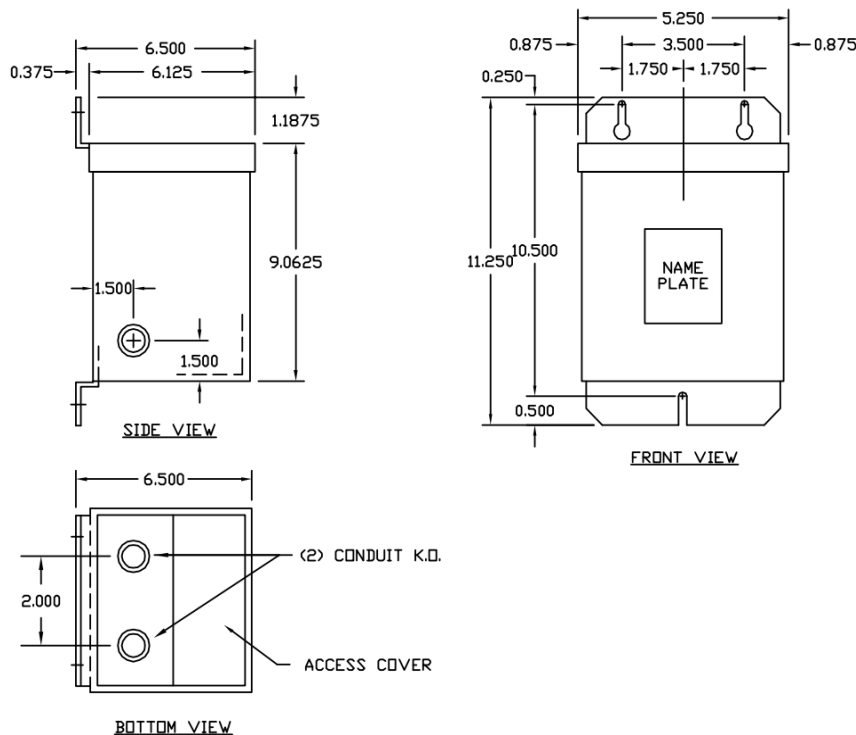
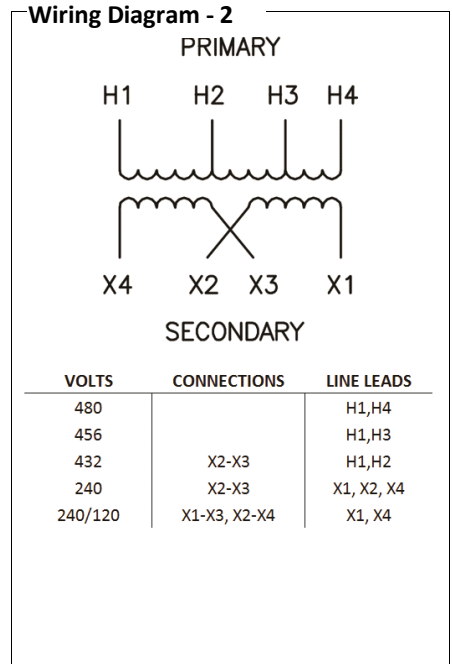

Outline No: 05A1463